

# RAZOR® SNOWPLOW BLADE SYSTEM

## INSTALLATION GUIDE

RAZOR® System
3 – RAZOR® Blade Sections (3 or 4 ft.)
2 – PlowGuard MAXX™
1 – Plow Bolt Kit (may contain extra hardware) 12 – 3" Plow Bolts (Blade assembly) 6 – 4-1/2" Plow Bolts (PlowGuard MAXX™ assembly)
18 – Stover Lock Nuts
18 – Washers

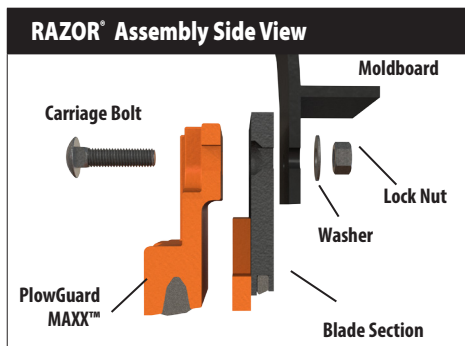
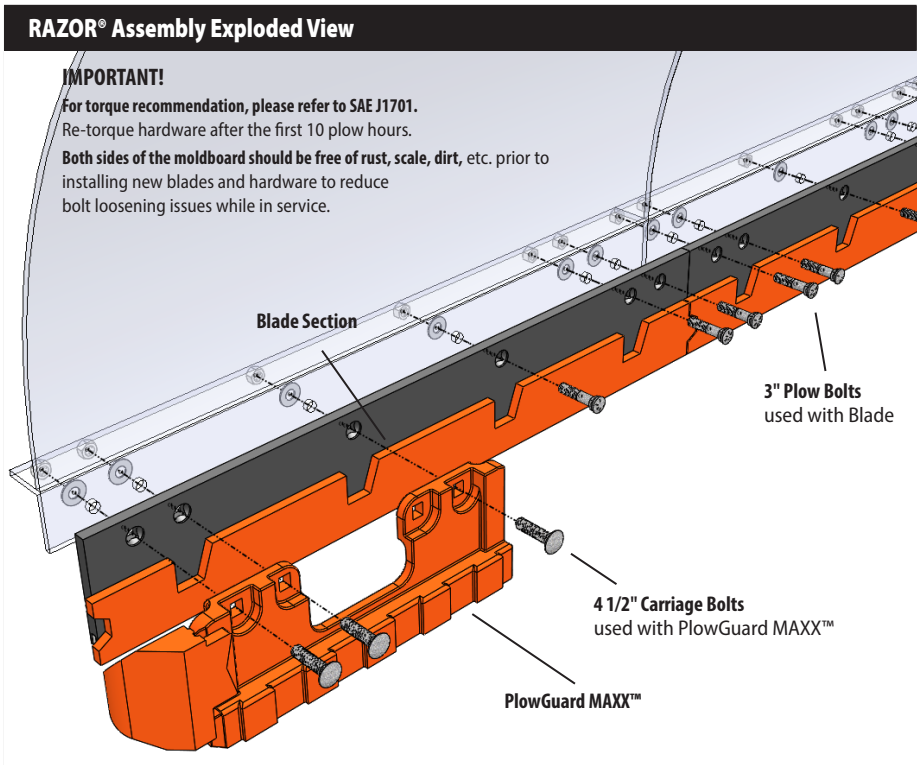

### 12' RAZOR® Setup

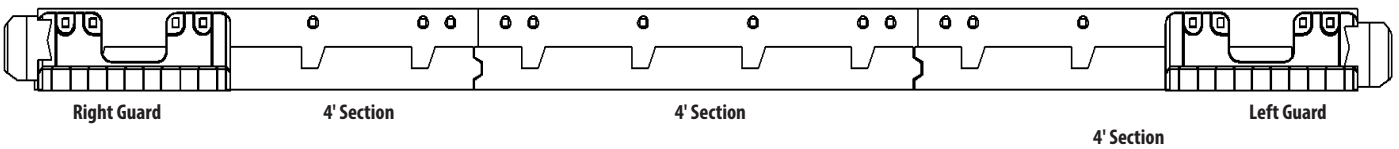

### 11' RAZOR® Setup

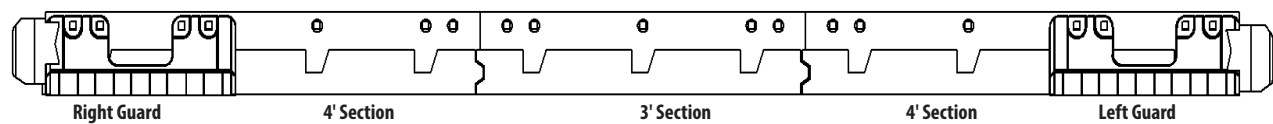

### 10' RAZOR® Setup

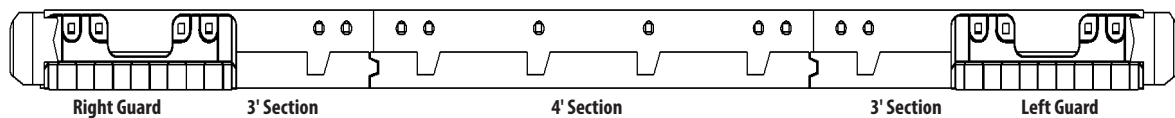

### 9' RAZOR® Setup

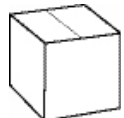
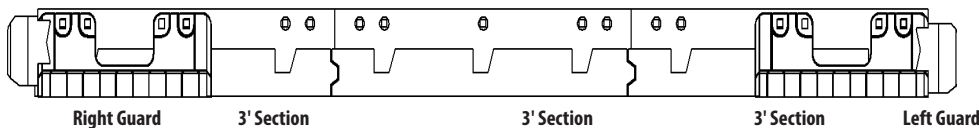

Plow Bolt Kit  
 Included With Every System



Questions? 1-800-294-6837 or [WinterEquipment.com](http://WinterEquipment.com)